



aparatos de alumbrado para ser instalados en superficie. Especialmente indicados cuando se requiere una iluminación cenital y no se dispone de falso techo donde alojar las luminarias. Los equipos de encendido, cuando son necesarios, están alojados en el interior de estos aparatos y en los casos en que se utilizan lámparas de descarga, los componentes de arranque son instalados de forma que se puedan realizar fácilmente los labores de mantenimiento.

La mayoría de estas luminarias pueden ser suspendidas tanto con tubos, que permiten su alimentación por el interior, como con cables de acero. Esto permite acercar las fuentes de luz a los planos de trabajo en los casos de techos especialmente altos y hace más sencillo su mantenimiento.

Pueden encontrar estas versiones en el apartado de luminarias suspendidas del presente catálogo.

	HIT-DE	TC-D	TC-DEL	QR-CB51	QR-111	PAR-38LED	PAR-30LED	GU10LED	LED	
	DESCARGA	FLUORESCENCIA		HALÓGENAS 12V.		LED				
7815				50W.						CARDAN
7801					100W.					
7001-7002-7003-7004								7W.		CUBE
7054-7055-7056								7W.		TUBE
7702							12W.			
7701						18W.				
7726		13W. 18W.								
7708	70W. 150W.									
7794		13W. 18W. 26W.								
7714		13W. 18W. 26W.								
7705-7706-7707				18W. 26W.						PIE
7013									1W.	LED

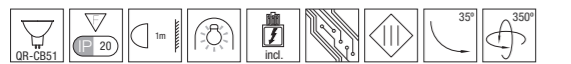

acero y alum. inyectado/ steel & die cast alum.

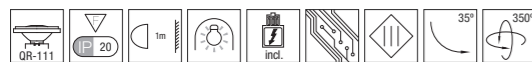
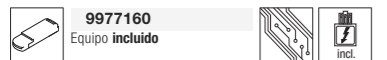

acero y alum. inyectado/ steel & die cast alum.

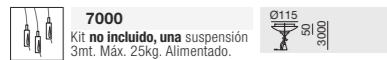
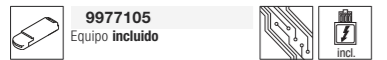

aluminio/ aluminium



Versión empotrable.
pág. ---



Su compacto di-
seño permite la ins-
talación en vertical.



aluminio/ aluminium



Versión empotrable.
pág. ---



Su compacto di-
seño permite la ins-
talación en vertical.

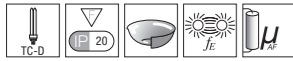

7726 012	G-24d-1	TC-D	2X13W.
7726 017	G-24d-2	TC-D	2X18W.

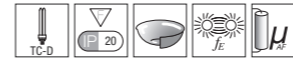

7794 012	G-24d-1	TC-D	2X13W.
7794 017	G-24d-2	TC-D	2X18W.
7794 025	G-24d-3	TC-D	2X26W.

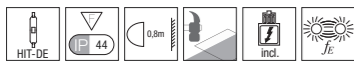

7708 275	Rx-7s	HIT-DE	70W.
7708 255	Rx-7s	HIT-DE	150W.

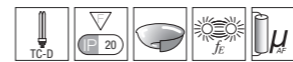
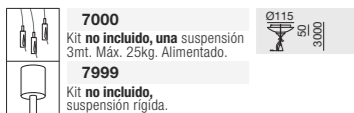

7714 012	G-24d-1	TC-D	2X13W.
7714 017	G-24d-2	TC-D	2X18W.
7714 025	G-24d-3	TC-D	2X26W.

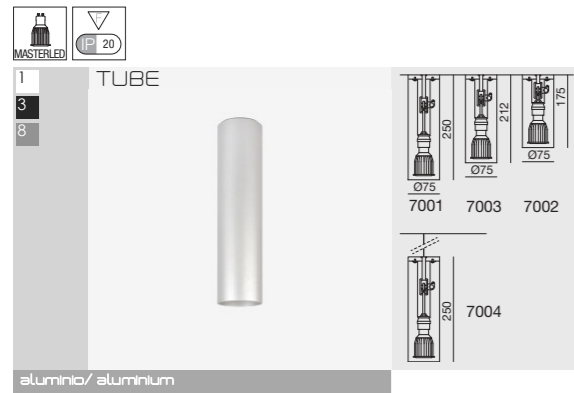

7001 907	Gu10	MASTERLED	7W.
7002 907	Gu10	MASTERLED	7W.
7003 907	Gu10	MASTERLED	7W.
7004 907	Gu10	MASTERLED	7W.

aluminio/ aluminium

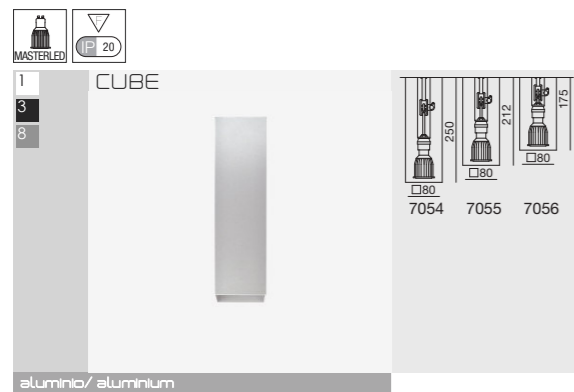

7054 907	Gu10	MASTERLED	7W.
7055 907	Gu10	MASTERLED	7W.
7056 907	Gu10	MASTERLED	7W.

aluminio/ aluminium

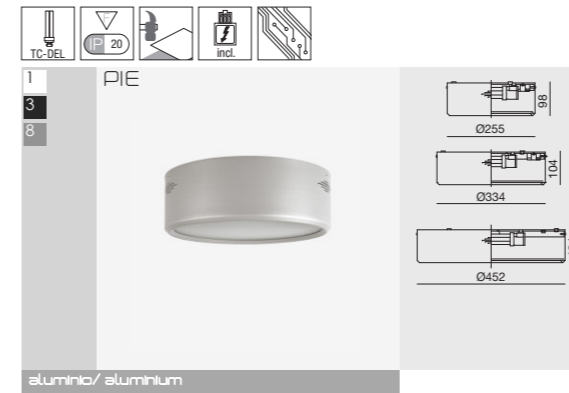

7705 118	G-24q-2	TC-DEL	2X18W.
7705 126	G-24q-3	TC-DEL	2X26W.
7707 118	G-24q-2	TC-DEL	3X18W.
7707 126	G-24q-3	TC-DEL	3X26W.
7707 118	G-24q-2	TC-DEL	3X18W.
7707 126	G-24q-3	TC-DEL	3X26W.

aluminio/ aluminium



7013 903	1LED	350mA.	1W.
-----------------	------	--------	-----

alum. inyec. y polyc/ die cast alum. & polyc.

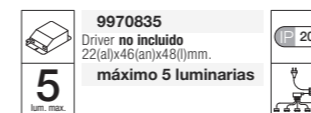

5 lum. máx.

